

User Manual

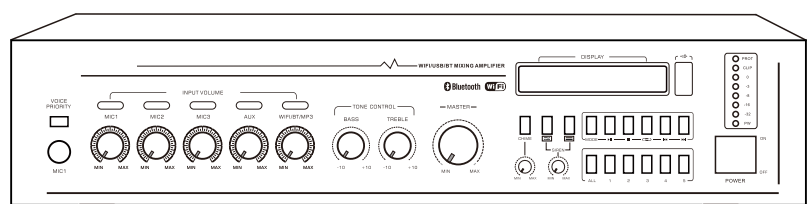

WIFI/USB/BT MIXING AMPLIFIER

Thank you for purchasing the **WIFI/USB/BT Mixing Amplifier**.
 Please carefully follow the instructions in this manual to ensure long,
 trouble-free use of the equipment.

Packaging Contents

WIFI amplifier.....1
 User manual.....1
 AC power cord.....1
 Antenna.....1
 Audio cable.....1
 Mounting bracket.....1

SAFETY PRECAUTIONS

- ※ Be sure to read the instructions in this section carefully before use.
- ※ Make sure to observe the instructions in this manual as the conventions of safety symbols and messages regarded as very important precautions are included.
- ※ We also recommend you keep this instruction manual handy for future reference.



The lightning flash with arrowhead symbol, within an equilateral triangle, is intended to alert the user to the presence of uninsulated "dangerous voltage" within the product's enclosure that may be of sufficient magnitude to constitute a risk of electric shock to persons.



The exclamation point within an equilateral triangle is intended to alert the user to the presence of important operating and maintenance (servicing) instructions in the literature accompanying the appliance.

WARNING

When Installing the Unit

- ※ Do not expose the unit to rain or an environment where it may be splashed by water or other liquids, as doing so may result in fire or electric shock.
- ※ Use the unit only with the voltage specified on the unit. Using a voltage higher than that which is specified may result in fire or electric shock.
- ※ Do not cut, kink, otherwise damage nor modify the power supply cord. In addition, avoid using the power cord in close proximity to heaters, and never place heavy objects -- including the unit itself -- on the power cord, as doing so may result in fire or electric shock.
- ※ Be sure to replace the unit's terminal cover after connection completion. Because high voltage is applied to the speaker terminals, never touch these terminals to avoid electric shock.
- ※ Be sure to ground to the safety ground (earth) terminal to avoid electric shock. Never ground to a gas pipe as a catastrophic disaster may result.
- ※ Avoid installing or mounting the unit in unstable locations, such as on a rickety table or a slanted surface. Doing so may result in the unit falling down, causing personal injury and/or property damage.

When the Unit is in Use

※ Should the following irregularity be found during use, immediately switch off the power, disconnect the power supply plug from the AC outlet and contact your nearest dealer. Make no further attempt to operate the unit in this condition as this may cause fire or electric shock.

· If you detect smoke or a strange smell coming from the unit.

· If water or any metallic object gets into the unit.

· If the unit falls, or the unit case breaks.

· If the power supply cord is damaged (exposure of the core, disconnection, etc.)

· If it is malfunctioning (no tone sounds.)

※ To prevent a fire or electric shock, never open nor remove the unit case as there are high voltage components inside the unit. Refer all servicing to your nearest dealer.

※ Do not place cups, bowls, or other containers of liquid or metallic objects on top of the unit. If they accidentally spill into the unit, this may cause a fire or electric shock.

※ Do not insert nor drop metallic objects or flammable materials in the ventilation slots of the unit's cover, as this may result in fire or electric shock.

CAUTION**When Installing the Unit**

※ Never plug in nor remove the power supply plug with wet hands, as doing so may cause electric shock.

※ When unplugging the power supply cord, be sure to grasp the power supply plug; never pull on the cord itself. Operating the unit with a damaged power supply cord may cause a fire or electric shock.

※ When moving the unit, be sure to remove its power supply cord from the wall outlet.

Moving the unit with the power cord connected to the outlet may cause damage to the power cord, resulting in fire or electric shock. When removing the power cord, be sure to hold its plug to pull.

※ Do not block the ventilation slots in the unit's cover.

Doing so may cause heat to build up inside the unit and result in fire.

※ Avoid installing the unit in humid or dusty locations, in locations exposed to the direct sunlight, near the heaters, or in locations generating sooty smoke or steam as doing otherwise may result in fire or electric shock.

When the Unit is in Use

※ Do not place heavy objects on the unit as this may cause it to fall or break which may result in personal injury and/or property damage. In addition, the object itself may fall off and cause injury and/or damage.

※ Make sure that the volume control is set to minimum position before power is switched on.

Loud noise produced at high volume when power is switched on can impair hearing.

※ Do not operate the unit for an extended period of time with the sound distorting.

This is an indication of a malfunction, which in turn can cause heat to generate and result in a fire.

※ Contact your dealer as to the cleaning. If dust is allowed to accumulate in the unit over a long period of time, a fire or damage to the unit may result.

※ If dust accumulates on the power supply plug or in the wall AC outlet, a fire may result.

Clean it periodically. In addition, insert the plug in the wall outlet securely.

※ Switch off the power, and unplug the power supply plug from the AC outlet for safety purposes when cleaning or leaving the unit unused for 10 days or more.

Doing otherwise may cause a fire or electric shock.

LIMITED WARRANTY

We warrant that the hardware products it manufactures will be free from defects in materials and workmanship.

The warranty term, beginning on the date of invoice, is one year for Parts replacement, two years for parts repair and six months on accessories.

This warranty does not cover damage or failure caused by alterations, mishandling, abuse, misuse, neglect, accident or resulting from any cause other than a product defect.

In case of defects in material and workmanship under normal use and conditions, we will replace or repair products covered under this limited warranty that are returned to our facility.

To request warranty service, you must contact our international sales team within the warranty period, ship the products back to us in their original or equivalent packaging (freight prepaid). If we repair or replace a product, its warranty term is not extended.

DISCLAIMER

Information contained in this manual is subject to change without prior notice and does not represent a commitment on the part of the vendor. We shall not be liable for any loss or damages whatsoever arising from the use of information or any error contained in this manual.

It is recommended that all services and repairs on this product be carried out by us or its authorized dealer.

This product must only be used for the purpose it was intended by the manufacturer and in conjunction with this operating manual.

We cannot accept any liability whatsoever for any loss or damages caused by service, maintenance or repair by unauthorized personnel, or by use other than that intended by the manufacturer.

DESCRIPTION & FEATURE

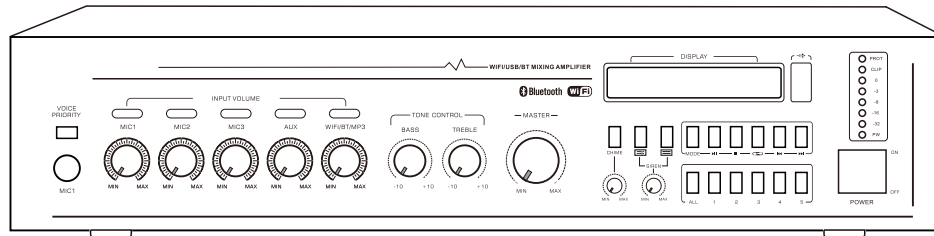

The WiFi/USB/BT Mixing Amplifiers are designed to meet the requirements of medium sized professional public address installations, and designed with overall 70/100-volt and 4/8 ohms(Ω) loads and featured an industry leading 5 zoned 100 volt load solution, 120/240/350 watts of amplifier power are available, with provided an audio output to 5 different zones within the venue, each zone has its own separate switch on/off manually operated on front panel.

Its outstanding feature of WiFi wireless music streaming receiver, supports connection with your smart device via a free APP, one RJ45 port is available on the rear panel as a backup for the point where the WiFi signal is weaker. Three microphone jacks support 48V Phantom Power microphone and 6.35mm plug microphone, pushing the button "VOICE PRIORITY" the MIC1 can be set with priority over the other inputs.

All units feature protections against operation under quite severe misuse such as over temperature, over voltage, over load and short circuit speaker line conditions.

- ※ Built-in WiFi wireless music streaming receiver, Bluetooth receiver and USB player.
- ※ Connect with your smart device via the free app.
- ※ Support AIRPLQY/D LAN/Q PLAY.
- ※ One RJ45 port available for the point where the WiFi signal is weaker.
- ※ 70/100-volt and 4/8 ohms(Ω) output loads.
- ※ 5 Zones 100V speaker outputs with separate switch ON/OFF.
- ※ Powerful amplifier tubes.
- ※ Three 48V Phantom Power jacks, suitable for unbalanced 6.35mm plug microphone.
- ※ Mic 1 has priority over the inputs.
- ※ High-definition display for the working status of playing programme.
- ※ Built-in Chime and Siren circuitry with push-button and volume control.
- ※ BASS and TREBLE tone controllers. Master volume control.
- ※ Complete protection provided for output short circuit, overload, high temperature.
- ※ Removable rack mounting brackets supplied.

FRONT PANEL

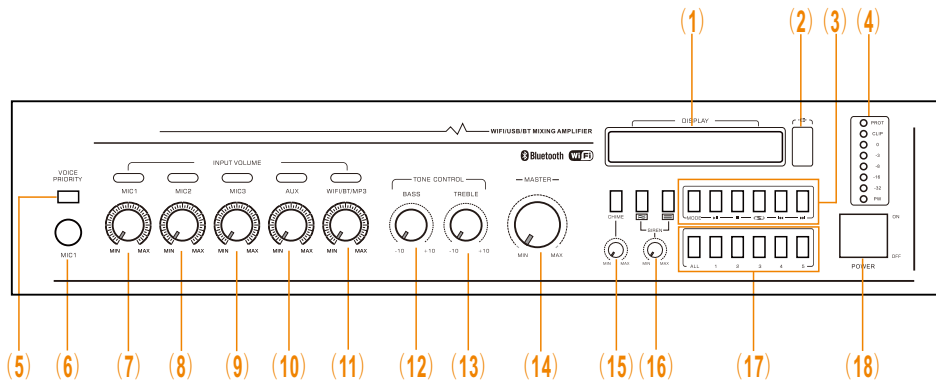

- (1) **SCREEN:** Displays the working status of playing programmes.
- (2) **USB INPUT INTERFACE:** Allows you to play USB disk.
- (3) **MP3 CONTROLLERS:**
MODE To select the mode among WiFi,USB and bluetooth.
▶|| This button play or pause USB/BT song.
■ This button stop USB/BT song.
🔄 To press this button to play the USB songs repetitively for one or all.
⏮ This button shall return to the previous USB/BT song.
⏭ This button shall skip to the next USB/BT song.
- (4) **LED INDICATORS:**
PW Lights red when the amplifier is powered on.
-32/-16/-8/-3/0 Flashes according to the audio level.
CLIP Lights yellow when amplifier is overdriven.
PROT Lights red in the case of protection.
- (5) **VOICE PRIORITY:** To press this button to provide Auto-Mute function for MIC 1.
- (6) **MIC1:** 6.35mm microphone input jack.
- (7) **MIC1:** Allows you to control the volume of MIC1 input.
- (8) **MIC2:** Allows you to control the volume of MIC2 input.
- (9) **MIC3:** Allows you to control the volume of MIC3 input.
- (10) **AUX:** Allows you to control the volume of AUX input.
- (11) **MP3/BT/WIFI:** Allows you to control the volume of USB,bluetooth or WiFi input.
- (12) **BASS:** Controls the bass tone of the amplifier output.
- (13) **TREBLE:** Controls the treble tone of the amplifier output.
- (14) **MASTER:** The master volume control to collectively control the sound level of all outputs.
- (15) **CHIME:** Chime tone activator and its volume control.
- (16) **SIREN:** Two siren tone activators and volume control.
- (17) **ZONE CONTROLLERS**
- (18) **POWER:** Power switch ON/OFF.

REAR PANEL

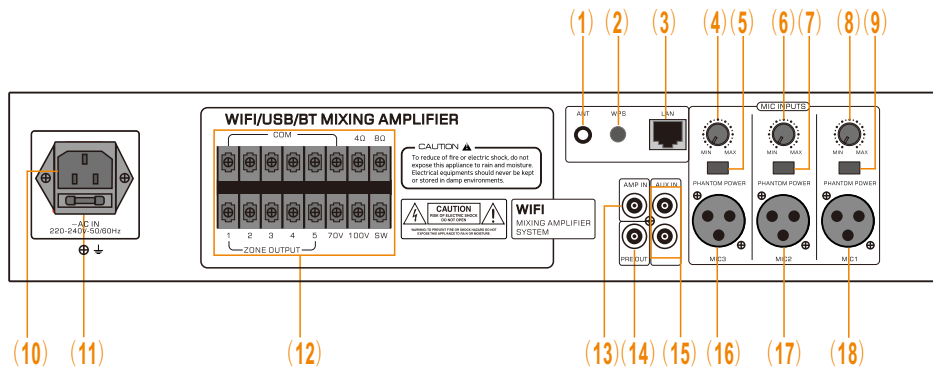

- (1) **BT/WIFI ANTENNA JACK**: Using a special antenna allows for long-distance connection.
- (2) **WPS BUTTON**: Pressing it for 6–8 seconds then it will restart to its original factory state.
- (3) **LAN PORT**: Allows you to use network cable for the connection when the WiFi signal is weaker.
- (4) **MIC3 VOLUME CONTROL**: Allows you to control the volume of MIC3 on the rear.
- (5) **MIC3 PHANTOM POWER SWITCH**: Push to switch on or off the MIC3 48V Phantom Power.
- (6) **MIC2 VOLUME CONTROL**: Allows you to control the volume of MIC2 on the rear.
- (7) **MIC2 PHANTOM POWER SWITCH**: Push to switch on or off the MIC2 48V Phantom Power.
- (8) **MIC1 VOLUME CONTROL**: Allows you to control the volume of MIC1 on the rear.
- (9) **MIC1 PHANTOM POWER SWITCH**: Push to switch on or off the MIC1 48V Phantom Power.
- (10) **AC POWER INLET**: It accepts a standard 3-pin cable.
- (11) **AC FUSE DRAWER**: Contains one main fuse and one spare fuse.
- (12) **SPEAKER OUTPUT TERMINALS**: Please refer to its connection details on page 9 to 10.
- (13) **AMP IN**: It receives the signal from PER OUT of previous amplifier.
- (14) **PRE OUT**: It sends signal to AMP IN of next amplifier.
- (15) **AUX INPUT**: It accepts stereo “L” & “R” RCA connection, then converted to mono mode internally.
- (16) **MIC3 JACK**: It accepts balanced XLR connection and unbalanced 6.35mm connection.
- (17) **MIC2 JACK**: It accepts balanced XLR connection and unbalanced 6.35mm connection.
- (18) **MIC1 JACK**: It accepts balanced XLR connection and unbalanced 6.35mm connection.

SPECIFICATION

Model			
Rated Power	120W	240W	350W
Speaker Output Mode	Low impedance:4 & 8 ohms (Ω)		
	Voltage line:70V & 100V		
WiFi Solution	MUZO Wireless Hi-Fi System		
WiFi APP Name	MUZO Player		
WiFi APP Version	Android, iOS		
Wi-Fi Mode	Wi-Fi 8.2.11 b/g/n(AP/STA modes supported)		
Music Format	Supported with MP3,WMA,ACC(ACC+),Apple lossless,ALAC,FLAC,APE,WAV		
Frequency Response	60 Hz ~ 15k Hz (± 3 dB)		
T.H.D	<1% at 1kHz,1/3 rated power		
S/N	≥ 75 dB		
Tone Control	BASS:100 Hz (± 10 dB) , TREBLE:10k Hz (± 10 dB)		
Audio Input	MIC,AUX, USB, BLUETOOTH, WIFI		
Protection	Short circuit,overload,high temperature		
AC Fuse	T2A	T4A	T6A
Power Supply	AC 220-240V- 50/60Hz		
Power Consumption	185W	350W	485W
Power Cord	$(3 \times 0.75 \text{ mm}^2) \times 1.5\text{M}$		
Dimension (HxWxD)	100x430x340mm	100x430x340mm	100x430x340mm
Carton Size	185x520x435mm	185x520x435mm	185x520x435mm
Net Weight	9.00 kgs	11.80 kgs	14.30 kgs
Gross Weight	10.50 kgs	13.30kg	15.80 kgs

*Note: This device needs to be on a 2.4GHz Wi-Fi band

Specifications are typical; individual unit might vary.

Specifications are subject to change and improvement without prior notice.

CONNECTION ILLUSTRATION

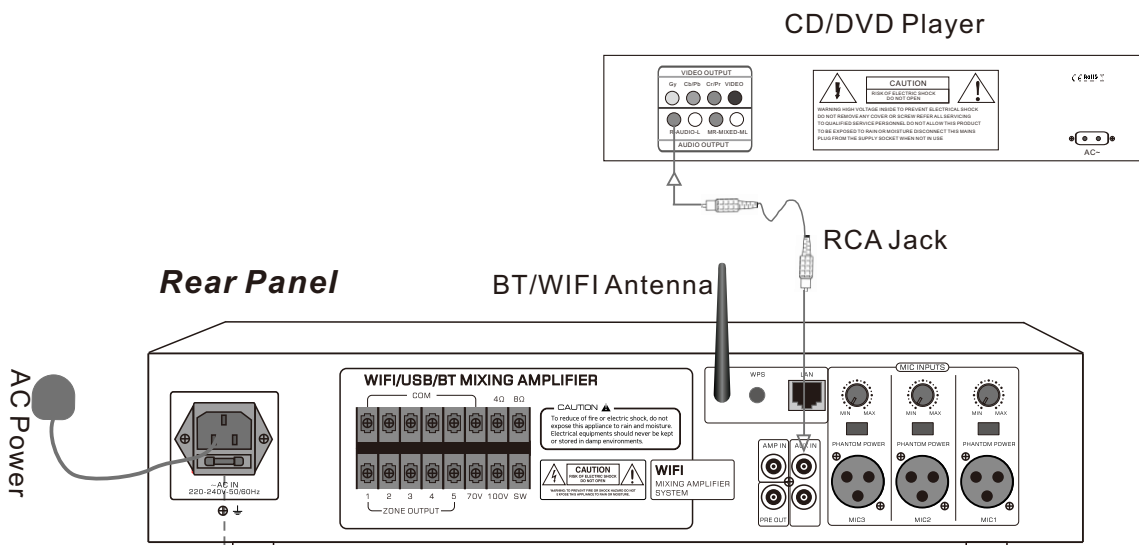
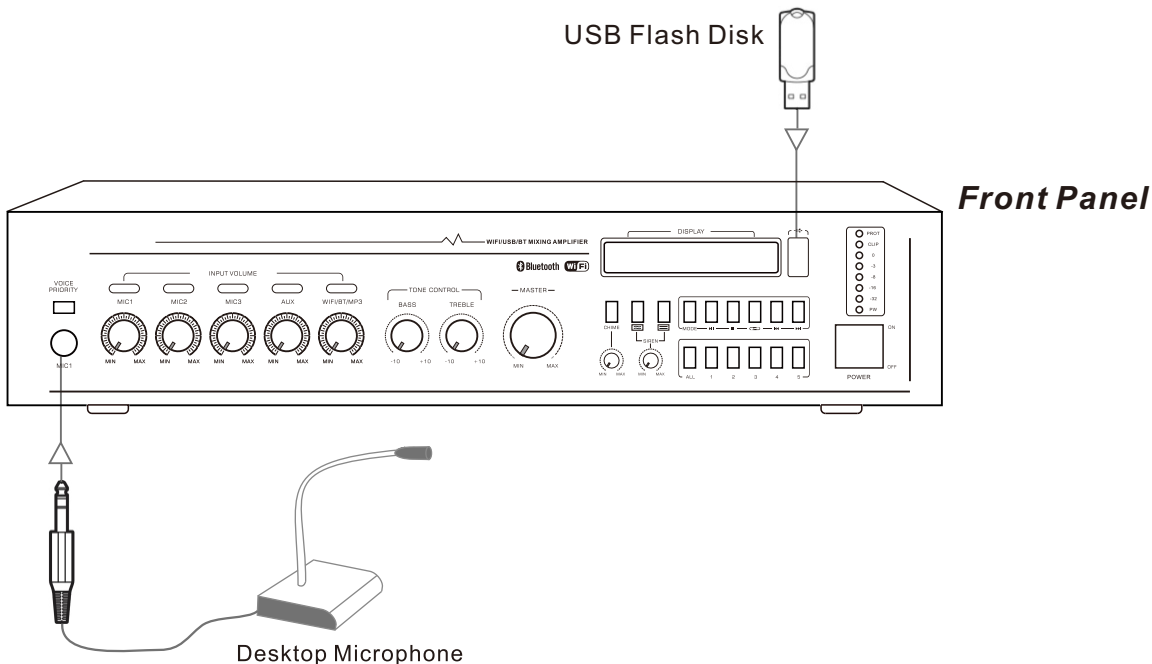

Fuse
 Fuse for protection against surges and short circuit.
 If the amplifier suddenly turns off and will not turn on, check the fuse and replace it if necessary.

- * Notes:**
- Please refer to page 9 to 10 for details of connections of speakers.
 - Please refer to page 11 for details of Bluetooth operations.
 - Please refer to page 12 to 18 for details of WiFi operations.

SPEAKER CONNECTION

Important Notes:

This amplifier has different loudspeakers outputs of 100V,70V and low impedance 4Ω/8Ω. **It's only possible to use one output at the same time, connecting more than one may damage internal parts of the amplifier. Each of 100V,70V,4Ω and 8Ω terminals must work with COM. (common) terminal.**

100V line output

This system is most commonly used in for PA system. Only use 100 V line loudspeakers with transformers. All loudspeakers are wired in parallel and the sum of their power must not exceed the rated output power of the amplifier. **It is advisable not to load the amplifier at more than 70% of its rated output power when using music sources.**

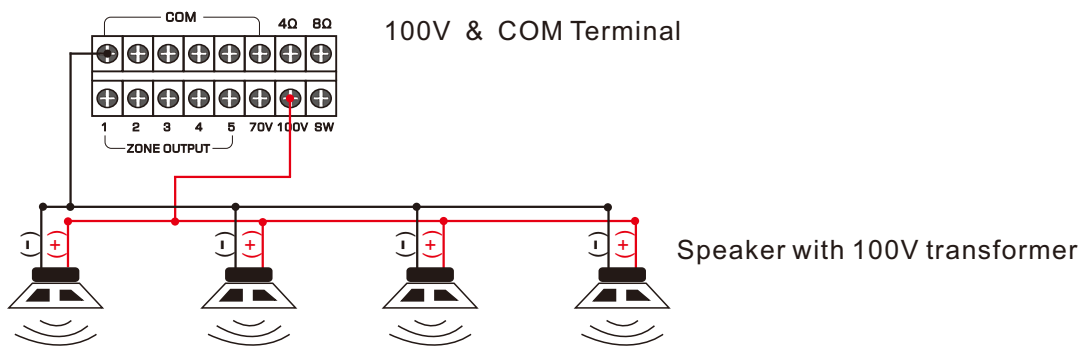

70V line output

This system is common in the USA, it operates on the same principles as 100 V line except that at rated output power the amplifier has 70V RMS on its output terminals.

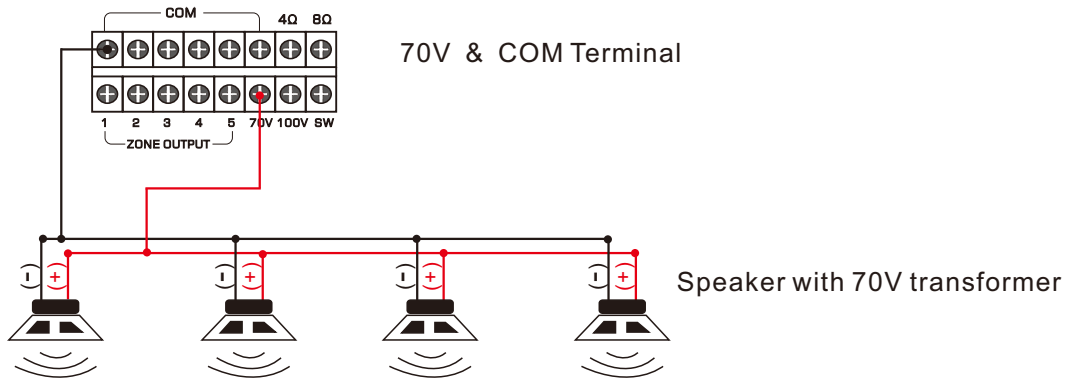

5 zone outputs

If the 5 zone speaker outputs are going to be used based on 100V, the terminal "100V" & "SW" have to be connected together using a cable, 70V shares the same principles as 100V.

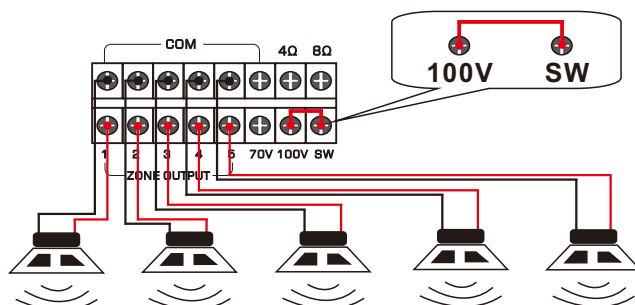

4Ω & 8Ω low impedance output

This output allows connection of low impedance loudspeakers without transformers, When two or more loudspeakers are used ensure that they are wired in such a way in Series, or in Parallel, or in Series & Parallel Combination that total load impedance remains at 4Ω or 8Ω.

A. Connecting speakers in Parallel.

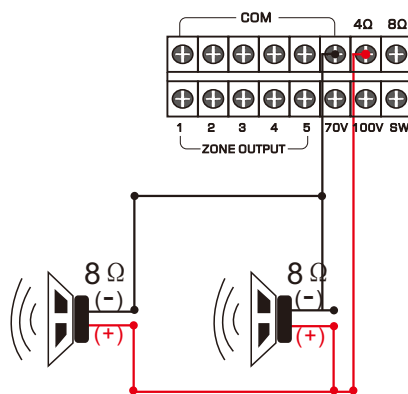

4Ω & COM Terminal

$$\frac{8\Omega}{2} = 4\Omega \text{ (Total load impedance)}$$

B. Connecting speakers in Series & Parallel combination.

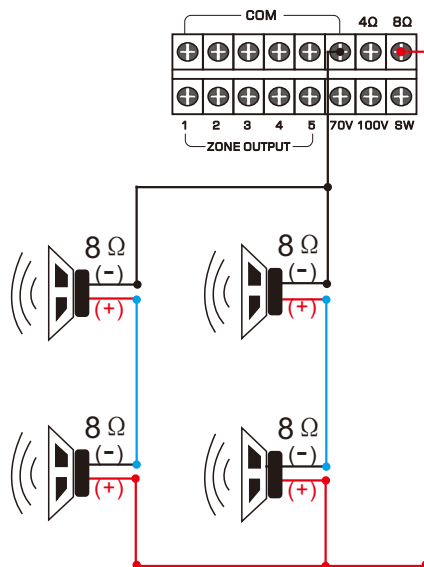

8Ω & COM Terminals

$$\frac{8\Omega \times 2}{2} = 8\Omega \text{ (Total load impedance)}$$

BLUETOOTH OPERATIONS



*Note: The Bluetooth name of this amplifier is “**BGM SYSTEM**”

In order to enjoy music from a Bluetooth device on this amplifier, the Bluetooth device must first be paired with this amplifier.

Once the Bluetooth device has been paired, it does not need to be paired again.

1. Press the MODE button on the front panel of the amplifier to switch the input source to “Bluetooth”.

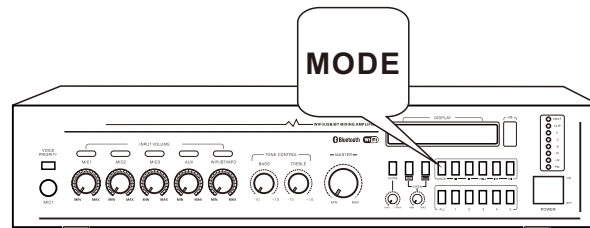

2. Activate the Bluetooth settings on your mobile device.



3. Select this unit “**BGM SYSTEM**” when its name appears in the list of devices displayed on the screen of your mobile device.

Perform the connection with your mobile device close to the unit (about 1 m).

At the end of the pairing, the name “**BGM SYSTEM**” appears on the paired list of your mobile device.

*Note: Enter “**1688**” when the password is requested on the screen of the your mobile device.

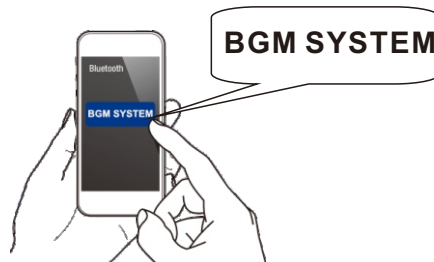

4. Play music using any app on your mobile device.

* The next time the input source is switched to Bluetooth, this amplifier automatically connects to the last Bluetooth device that was connected.



WIFI & APP OPERATIONS



This amplifier uses the public MUZO Wireless Hi-Fi System

The amplifier’s factory default Service Set Identifier(SSID) is: ex. “Linkplay_XXXX”

GETTING STARTED

Connect the amplifier with your speakers.

TURNING ON THE WIFI AMPLIFIER

To turn this unit ON, plug in the power cord. When the unit turns on, the indicator light will flash Red. In order to connect this device to your Wi-Fi, you need to know your network credentials.

MINIMUM REQUIREMENTS

This device is compatible with iPhone, iPod Touch and iPad devices running on iOS 6.0 or later and Android 2.3.3 or later.

NETWORK REQUIREMENTS

To access music services, Internet radio, and any digital music stored on your smart device or DLNA enabled Network-Attached Storage (NAS) device, your network must meet the following requirements:

NOTE: If you want to stream music through built-in App features such as Spotify, you will need to have a high speed internet connection. (Playback experience may differ depending on your internet connection speed.)

- If you are going to use the MUZO Player App on Android or iOS devices, a Wi-Fi Network will be required.
- You need to have your Wi-Fi network SSID and password.
- Your network configuration should not be in isolation mode.

CONNECT YOUR WIFI AMPLIFIER TO YOUR NETWORK VIA MUZO PLYAER APP.

- Install the MUZO Player App  to your Smartphone or Tablet.
- Ensure that your Smartphone is connected to the same network that you are going to connect your Wi-Fi to.
- Open the MUZO Player App and you will see the **Figure 1**.
- Select ‘Add Device’ at the bottom of the screen then you will see the **Figure 2**.
- Select ‘MUZO Cobblestone’ then you will see the **Figure 3**.

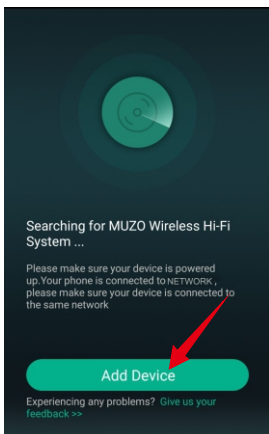

Figure 1

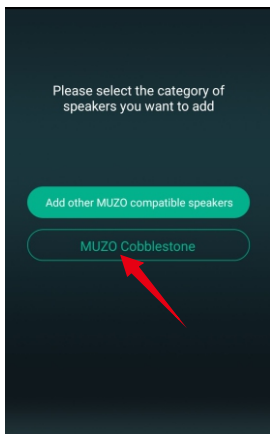

Figure 2

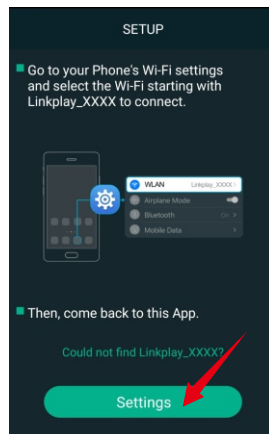

Figure 3

- Select ‘**Settings**’ then you will see **Figure 4**.
- Select the **WIFI AMPLIFIER’S SSID**, ex. “Linkplay_XXXX”, then you will see the **Figure 5**.
- Select ‘**CONNECT**’ then you will see the **Figure 6**.
- Select ‘**NO**’ you will see **Figure 7**, then press triangle ‘◀’ to exit the Wi-Fi discovery menu.

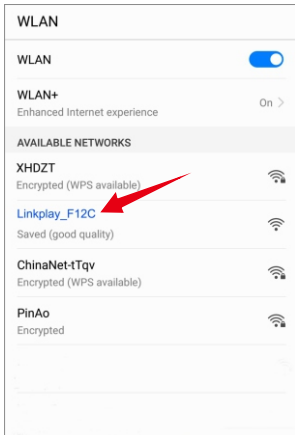

Figure 4

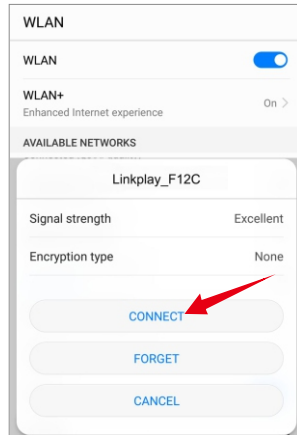

Figure 5

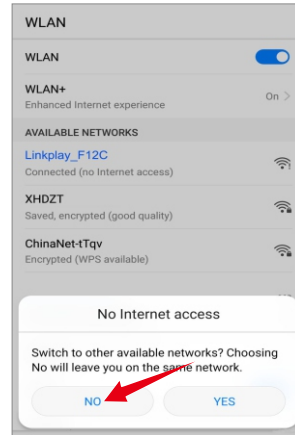

Figure 6

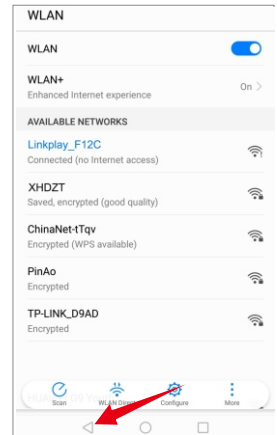

Figure 7

- Enter the MUZO Player APP, you will see the **Figure 7**.
- Select your Wi-Fi SSID and input its password, then ‘**Continue**’, when connected successfully you will see the **Figure 8**.
- Select ‘**Next**’, a pop up menu **Figure 9** will come up and you can select the name from pre-defined names or write a desired name for your unit. This will help you to easily differentiate units from one other on different locations (You cannot have two units with same name in the MUZO Player App).
- As the **Figure 10** shows, press the icon ‘▶’ to enter the DEVICE LIST as the **Figure 11**,

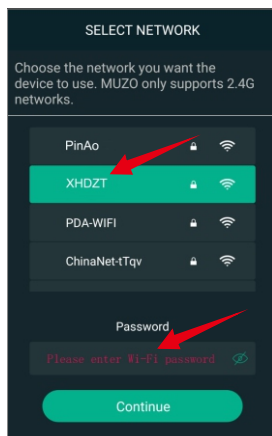

Figure 8

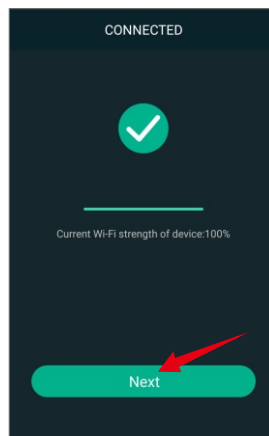

Figure 9

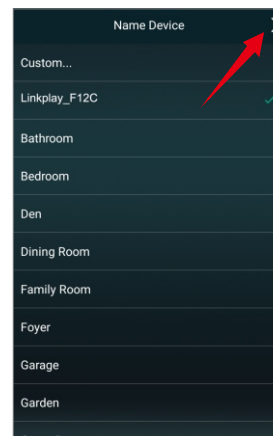

Figure 10

• Press the icon '◀' to enter the main screen as the **Figure 12**, in this menu we can select 'Add More Services' to configure which music services you want to display on your main screen list. Now you can play and enjoy your music!

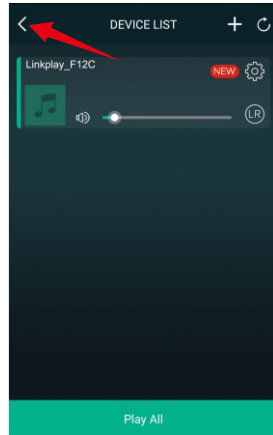

Figure 11

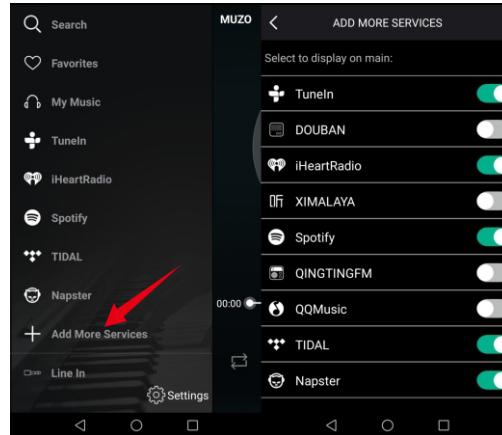

Figure 12

INSTRUCTIONS OF PLAYING MUSIC

My Music

Through 'My Music', you can access the music that you have saved on your iOS or Android device's internal storage. You can also access music stored in music server. There are other options such as "recently played" and user created playlists etc.

In iOS, only music sync from your iTunes are accessible by the MUZO player. It is grouped by artists, album, playlists, or track. In each category, it is in alphabetical order. On Android device, all the music in the device is accessible, and it can be grouped by folder too.

Spotify

You can control music play through your Spotify app. Go to the Connect screen and select your Amplifier. For example, 'Family Room' Once you connect, you can stream Spotify to any room connected with a WiFi amplifier.

In order to use Spotify on your WiFi amplifiers you need to install Spotify on your connected Smartphone or Tablet. Go to the App Store or the Play Store and search for the Spotify App. Install the App and login into your account. If you do not have an account you will need to set one up.

iHeartRadio

iHeartRadio allows you to stream radio stations to your WiFi amplifier. Enter the menu and select 'iHeartRadio'. Select 'Genre' to choose the genre of radio you would like to listen to or select 'Country' and then the 'Region' to select localized radio stations.



You can play music through AirPlay on your iOS device. To do this you need to ensure that your iOS device and the WiFi amplifiers are connected to the same Wi-Fi network. Swipe up from the bottom of your iOS device and select 'AirPlay'. Select your WiFi amplifier and start playing your music.

NOTE: On multi-channel mode when you have two or more WiFi amplifier together, selecting AirPlay will play the selected music on all the amplifiers. Ensure that you increase the volume on the unit when listening to music on AirPlay.



TIDAL is the perfect match for the WiFi amplifier, streaming music in lossless, high fidelity audio quality, ensuring the best sound experience possible. Add high definition music videos, curated editorials by music journalists, artists and experts, and so much more.

NOTE: Currently only available on iOS.



TuneIn allows you to stream different channels of music and streaming talk radio. Enter the menu and select 'TuneIn'. Afterwards you will be prompted to localize or select a genre of music to begin playing.



TuneIn allows you to stream different channels of music and streaming talk radio. Enter the menu and select 'TuneIn'. Afterwards you will be prompted to localize or select a genre of music to begin playing.



With millions of tracks on QQMusic, the right music is always at your fingertips whether you're working out, playing or relaxing. Diversified ways are here to discover music you will love. The latest hits, the artists or DJs you like, intelligent recommendation based on your listening history, your next favorite songs are waiting for you.

NOTE: Currently only available on iOS.



Enjoy live radio, news, music, fiction, comic, and podcast radio service.

NOTE: Currently only available on iOS.

CHECK WI-FI STRENGTH

To achieve smooth streaming experience, your WIFI AMPLIFIER should have good network connection with your connected router. When connected with Wi-Fi, please check the Wi-Fi strength when you have problem with streaming experience. The steps to check the Wi-Fi strength are as follows:

1. Enter the **DEVICE LIST** menu.
2. Select the gear '⚙️' icon on the WiFi speaker you want to check, then you will see the **Figure 13**.
3. Select **“Speaker Info”** to see if your Wi-Fi connection is good enough as the **Figure 14**.

AMPLIFIER WI-FI PASSWORD PROTECTION

If you don't want the amplifier to be public, you can encrypt it by enabling **“Add Password Protection”**,

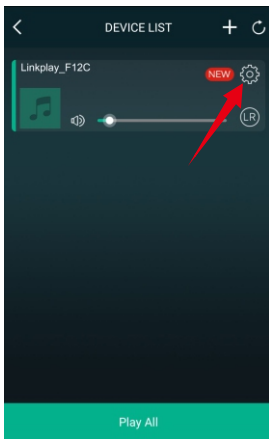

Device List

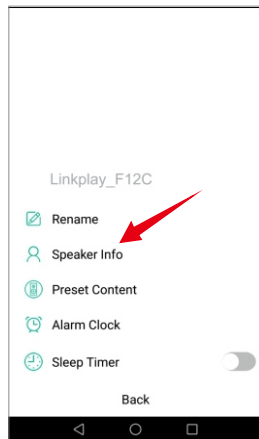

Figure 13

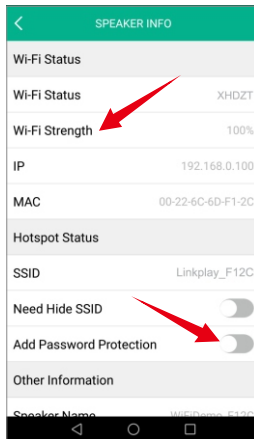

Figure 14

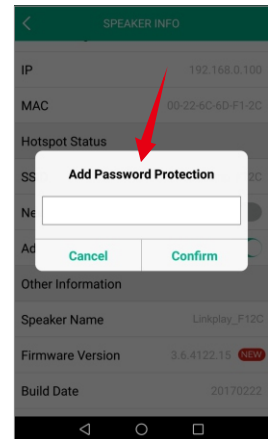

Figure 15

FACTORY RESET (Figure 16)

If you want to restore factory settings, select the **“Restore Factory Settings”** at the bottom of SPEAKER INFO menu to confirm.

FIRMWARE UPDATE (Figure 17)

If you see a **“New”** icon next to the setting button, it means a new firmware is available for your unit. In order to apply this firmware, tap on **“New”** and you will see a pop up message. Select upgrade and wait until the device upgrade process finishes.

NOTE: Do not conduct any other operation via the phone or the speaker unit while the firmware update is in progress.

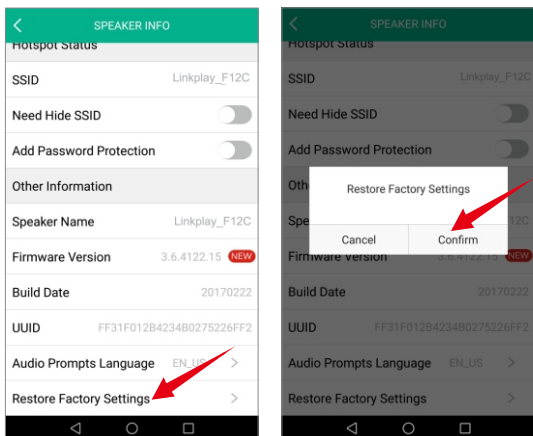

Figure 16

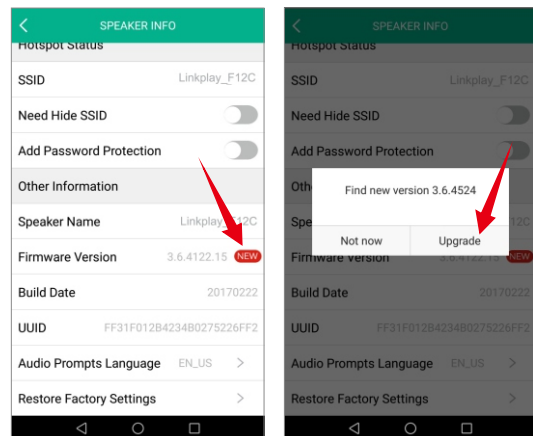

Figure 17

ALARM CLOCK (Figure 18)

The alarm lets you wake up to your own music from the iTunes library or your subscribed music services. You can set several alarms and specify for each alarm which days they should wake you up and which playlist to use.

SLEEP TIMER (Figure 19)

You can set a timer on your device and set a sleep timer for it to turn off.

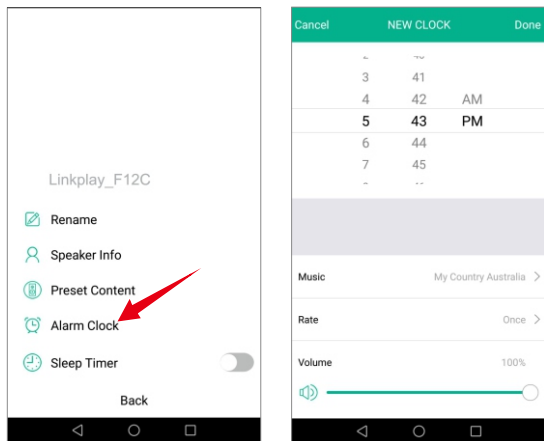

Figure 18

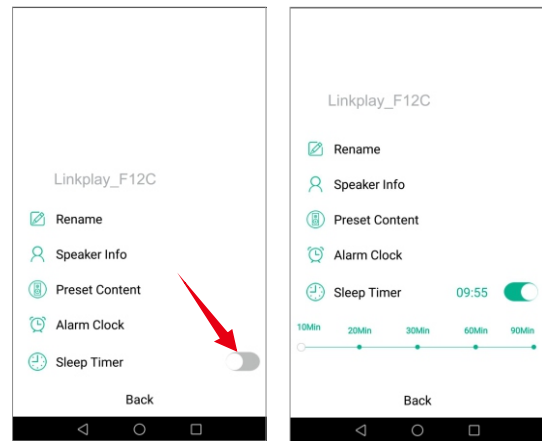
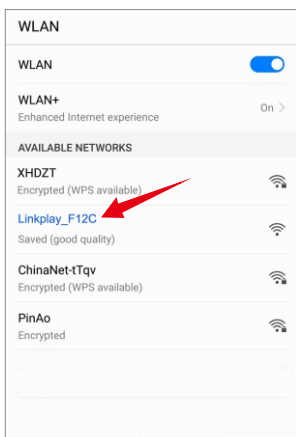

Figure 19

WEB BASED WI-FI SETUP

CONNECT AMPLIFIER TO WI-FI NETWORK (Figure 20)

- Open the **Wi-Fi Discovery Menu** on your Smartphone or Tablet and look for the Amplifier Service Set Identifier (SSID), ex. “Linkplay_XXXX”.
- Select to connect your device to the Amplifier hotspot network
- Open a web browser on your Smartphone or Tablet and input ‘10.10.10.254’ into the URL bar. This will lead you to the Wi-Fi setup page.
- Select your network from the list of available networks and input your home Wi-Fi password.
- Your device will disconnect from the Amplifier hotspot network and the amplifier will then connect to your Wi-Fi network.
- Your device will say “Connected” to indicate that your Amplifier has successfully connected to your Wi-Fi network.



Wi-Fi Discovery Menu

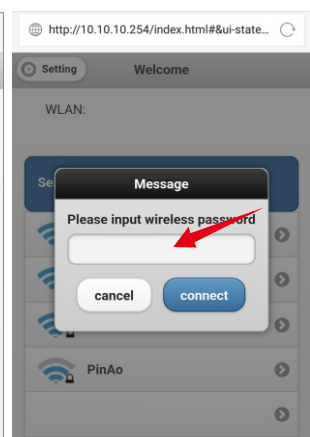
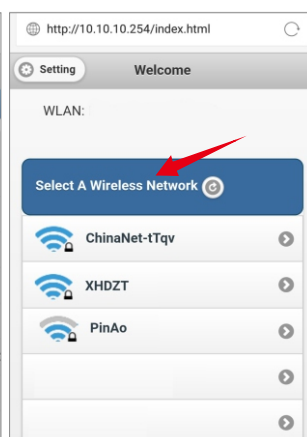

Connecting the speaker to Wi-Fi network

Figure 20

LANGUAGE SETUP (Figure 21)

You can click the “System” tab to select the language you want, then save it.

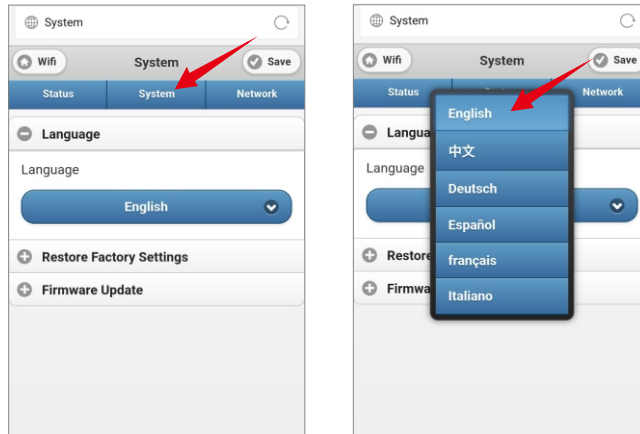

Figure 21

CHANGE DEVICE NAME (Figure 22)

The factory default device name is ex. “Linkplay_XXXX”, you can click the “Network” tab to “Change device name” to be the one you want, and click “OK” then to “Save” it.

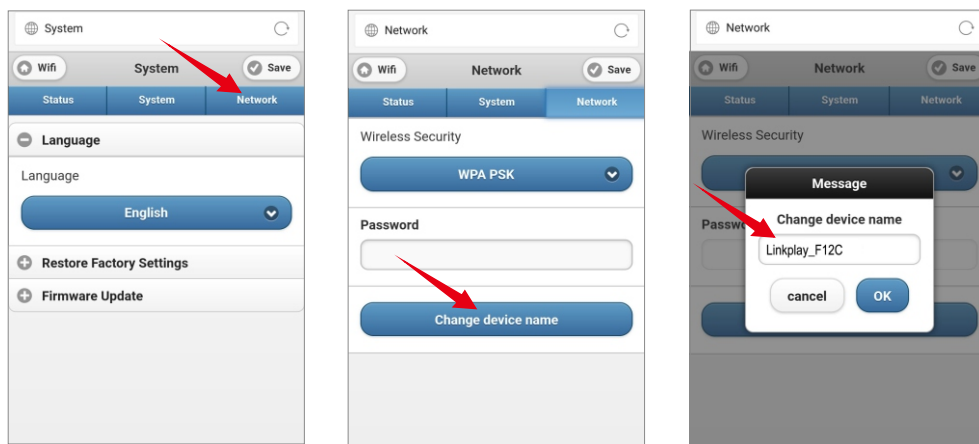

Figure 22

TROUBLESHOOT**SETTING UP THE AMPLIFIER****How do I connect the WIFI AMPLIFIER to my Wi-Fi network?**

You'll need to download the MUZO Player app for iOS or Android. Once you download it, the app will help you through the setup process.

I'm still having trouble setting up the Wi-Fi connection for my Amplifier. How can I fix the problem?

Try the following steps as an alternate way to set up your Wi-Fi connection:

1. Connect your phone or PC with your WIFI AMPLIFIER directly by finding the SSID (Format: Linkplay_XXXX) in your Wi-Fi setting.
2. Launch an internet browser in your device and enter <http://10.10.10.254>
3. Click the Wi-Fi button in the top left corner of the page, and select the router that you want to connect to. Enter the password to connect.

How do I initiate a factory reset? Here are two ways you can reset the WIFI AMPLIFIER:**Method 1:**

Locate the WPS button on the unit and press it for 6-8 seconds and then it will restart to its original factory state.

Method 2:

1. Find the unit you want to reset in the app.
2. Go to the Setting button and find "Speaker Info" and click "Restore Factory Settings".

How do I check if my WIFI AMPLIFIER firmware is up to date?

Please first refresh your "Device List" page. After you refresh, the app will prompt you to download firmware updates for any of your amplifier that do not have the latest firmware version. If this does not work for any reason, you can take the following steps to manually determine your firmware version and/or update your firmware:

1. Connect your computer or smartphone to the Amplifier Wi-Fi hotspot directly. Go to your device's wireless connection and select the Amplifier Wi-Fi SSID (the name format is "LinkPlay_XXXX").
2. Launch a web browser and enter <http://10.10.10.254> in the address bar.
3. To make sure you have the latest version, click the "System" tab and click on "Online Update". Update the firmware if needed and keep connection to Amplifier until firmware is complete.
4. Under the Status tab you can see the current firmware version number.

Will I be able to listen to Apple Music through the Amplifier from my iPhone, iPad, or Macbook Pro?

Yes.

How do I stream music from my DLNA enabled NAS (Network-Attached Storage) device?

First make sure your DLNA enabled NAS device is powered on and connected to the same wireless network as your Amplifier and smartphone/tablet. Tap the MUZO icon in the top left of the MUZO app. Select My Music, and select your device. You can then select music to stream from the DLNA enabled NAS device to your Amplifier. If you have any issues streaming music from your device, please check that your firmware is up to date.

Can I use my phone while playing music?

Yes, you can. Once your Amplifier is connected to your music, you can answer calls, make phone calls, turn off your phone and the speakers connected to your Amplifier will continue to stream music.

FREQUENTLY ASKED QUESTIONS**Can I stream music from my Mac or PC?**

Yes, you can stream from Mac or PC using iTunes Airplay.

On PCs you can also stream from Windows Media Player to your Amplifier via a UPnP or DLNA certified controller, such as Play To. Just make sure your device and Amplifier are all on the same wifi network.

Please follow these steps:

1. Open Windows Media Player
2. In the play list, Click Play To and select the Amplifier device

Or

1. Right click on the song and Click Play To
2. Music starts streaming.

If the Amplifier device is not visible on the Media Player, go to Stream > More streaming options, and make sure the Amplifier is in Allowed state.

Why can't I see a music service in my MUZO App even though its listed as a supported music service?

Your firmware may be out of date. In the MUZO app, if you refresh your device list page, it will automatically prompt you to download the latest firmware update.

Alternatively, you can manually check that your firmware is up to date. To update firmware:

In the MUZO app, if you refresh your device list page, it will automatically prompt you to download the latest firmware update.

Alternatively, you can take the following steps to manually determine your firmware version and/or update your firmware:

1. Connect your computer or smartphone to the Amplifier Wi-Fi hotspot directly. Go to your device's wireless connection and select the Amplifier Wi-Fi SSID (the name format is "LinkPlay_XXXX").
2. Launch a web browser and enter <http://10.10.10.254> in the address bar.

To make sure you have the latest version, click the "System" tab and click on "Online Update". Update the firmware if needed and keep connection to Speaker until firmware is complete.

Under the Status tab you can see the current firmware version number.

Can I login multiple WIFI AMPLIFIERS to Spotify at the same time?

You should be able to login multiple devices to your Spotify premium account but you can only stream Spotify from one device (or multi-room group) at a time. The Spotify App allows you to switch among different Spotify Connect clients. If you group multiple Amplifiers you'll only see the group master amplifier on the Spotify App.

What's the maximum number of Amplifier that can stream music on the same wireless network?

For this current version of the Amplifier you can have at most 6 in order to ensure a stable Wi-Fi connection. In future versions we are planning to allow more devices on the same Wi-Fi network, so appreciate your patience as we work on that!

Do the WIFI AMPLIFIER need to be on the same firmware version to stay in sync with one another?

Yes! Please keep the firmware in sync since we are still optimizing certain features that require the latest firmware.



NOTE:

Lined area for notes, consisting of multiple horizontal lines.



CAUTION: Do not open the equipment cover arbitrarily, so as not to electric shock. Please contact the professionals to maintain if necessary.